

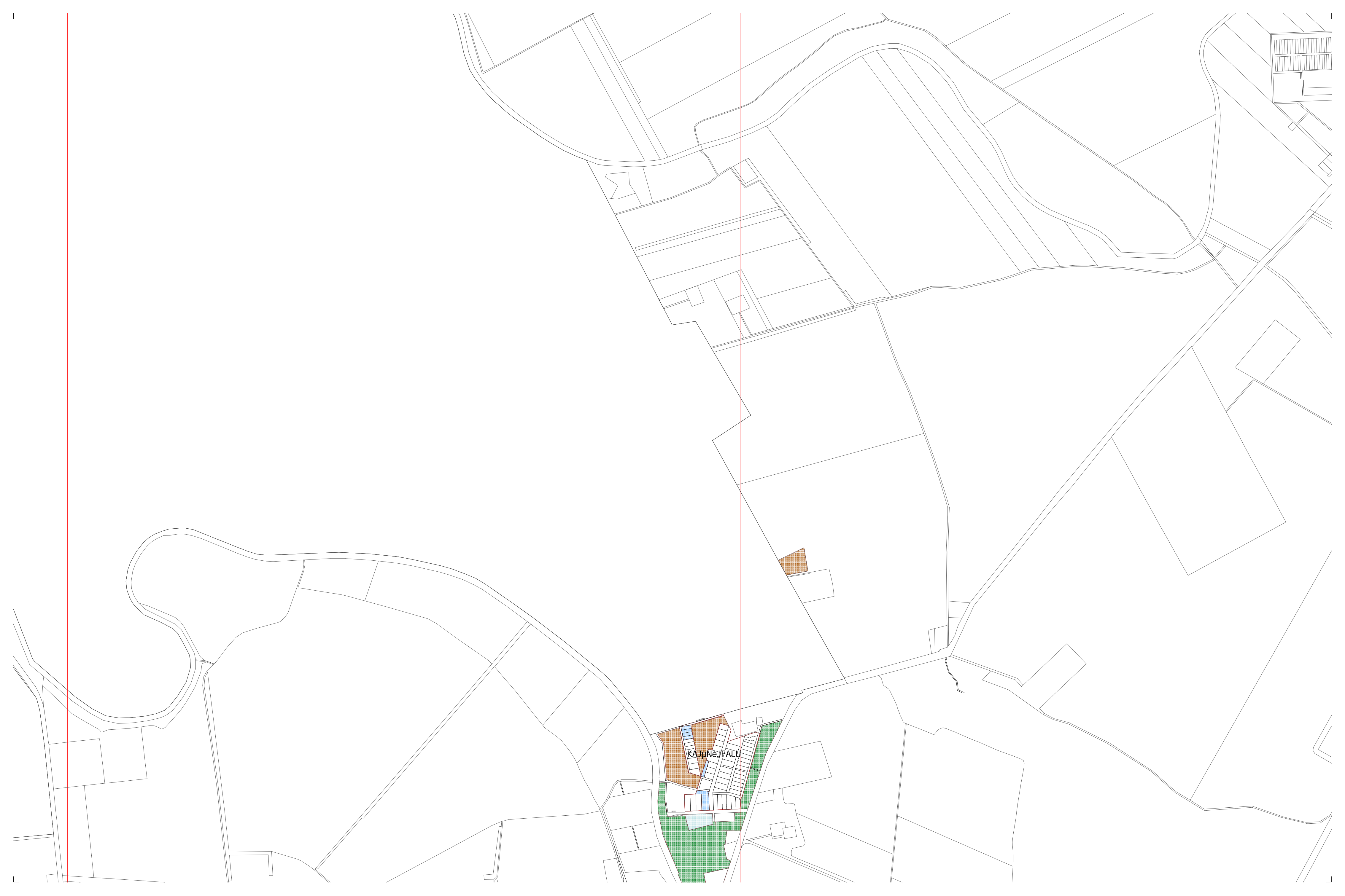

MAGYARTES





ΚΑΜΝΕΪΑΛΙ

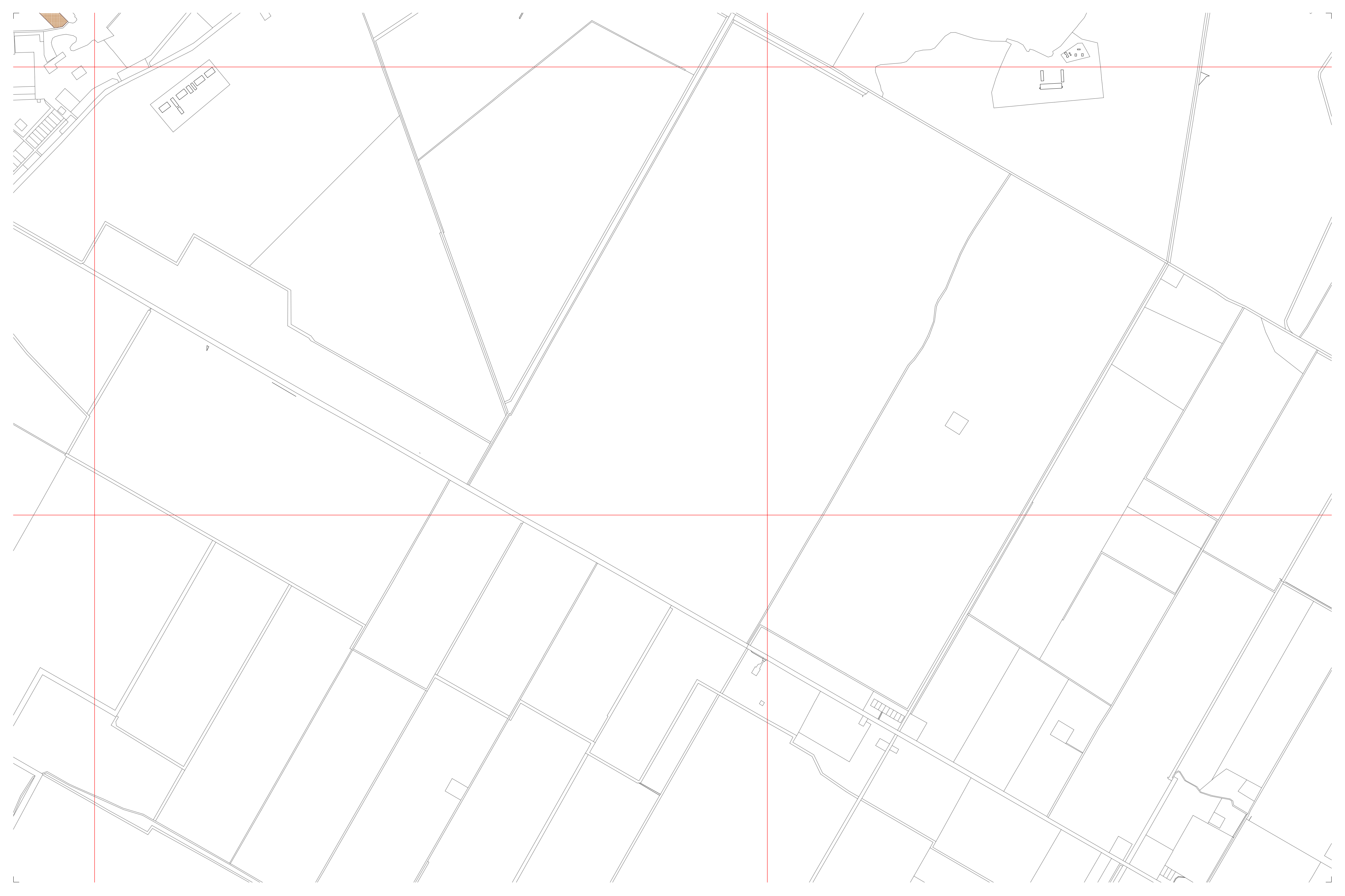





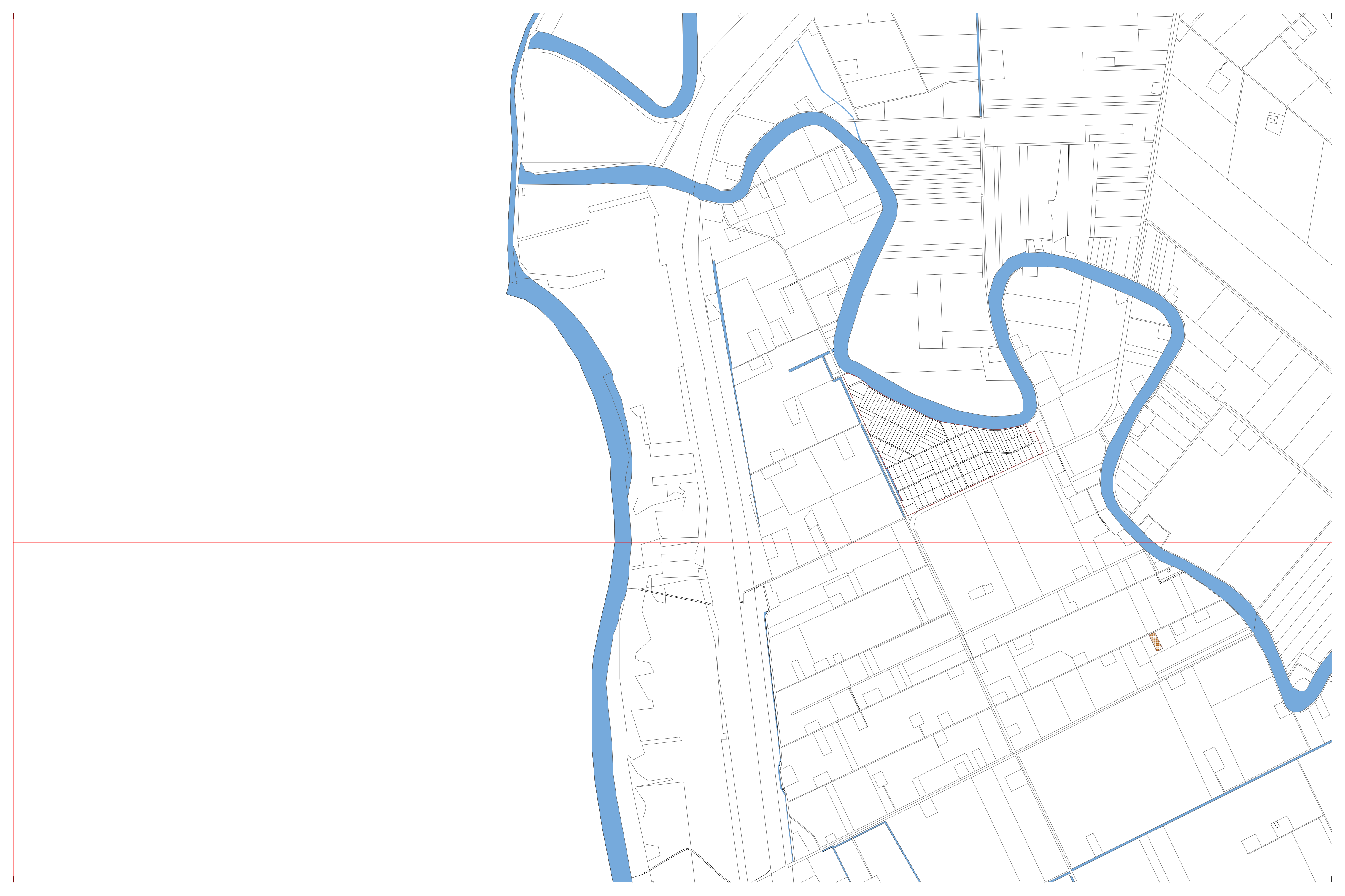

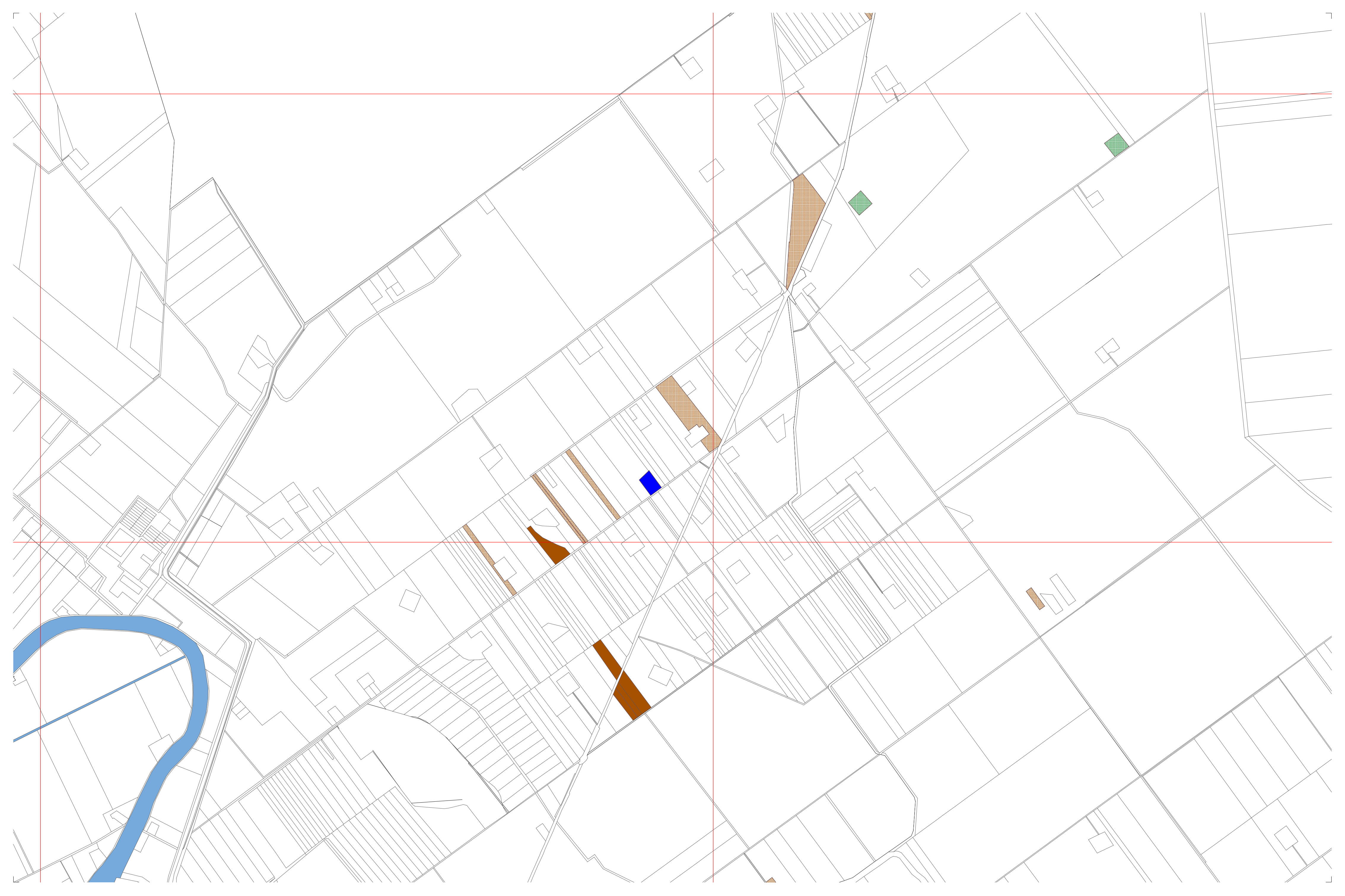

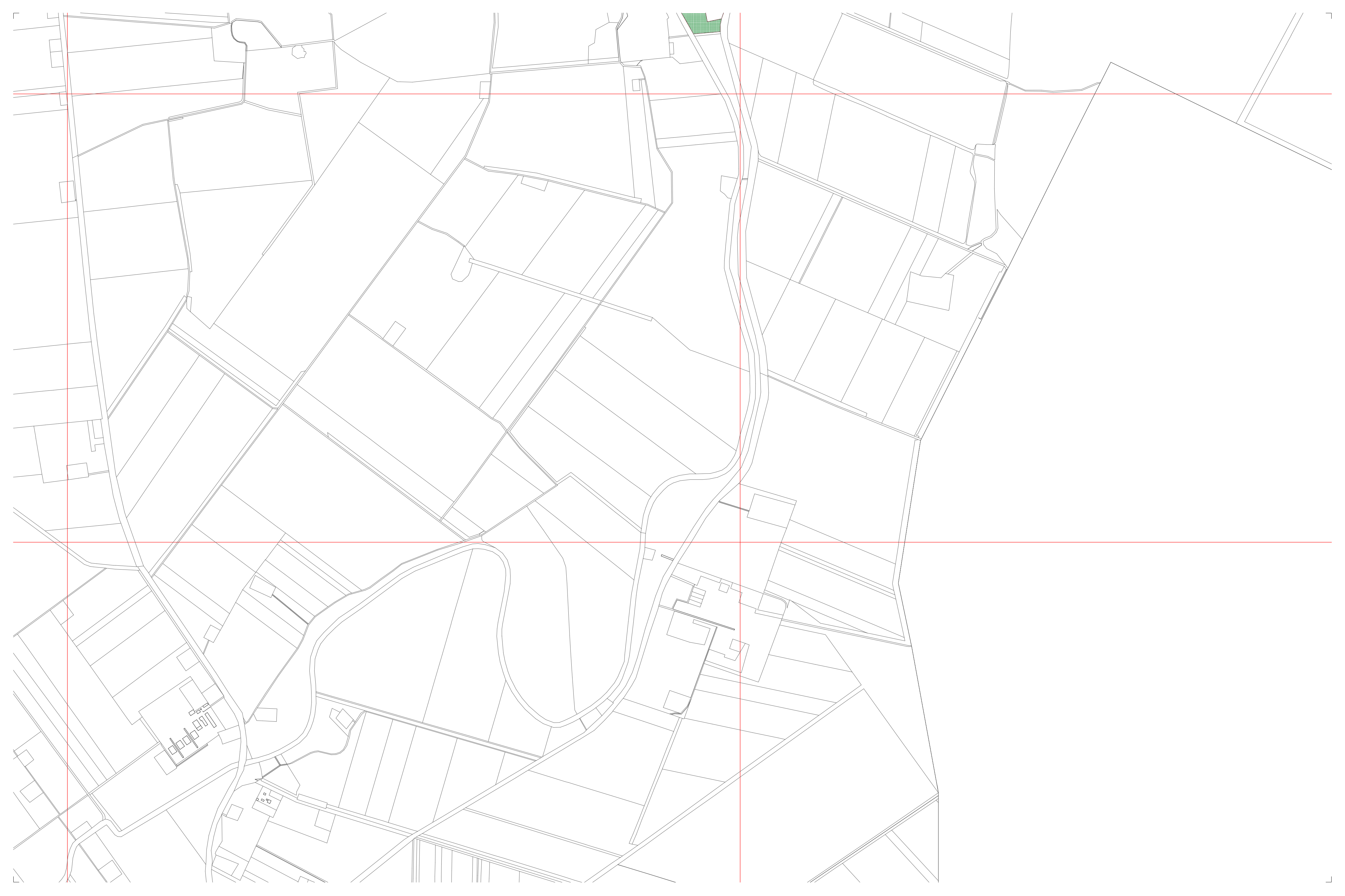

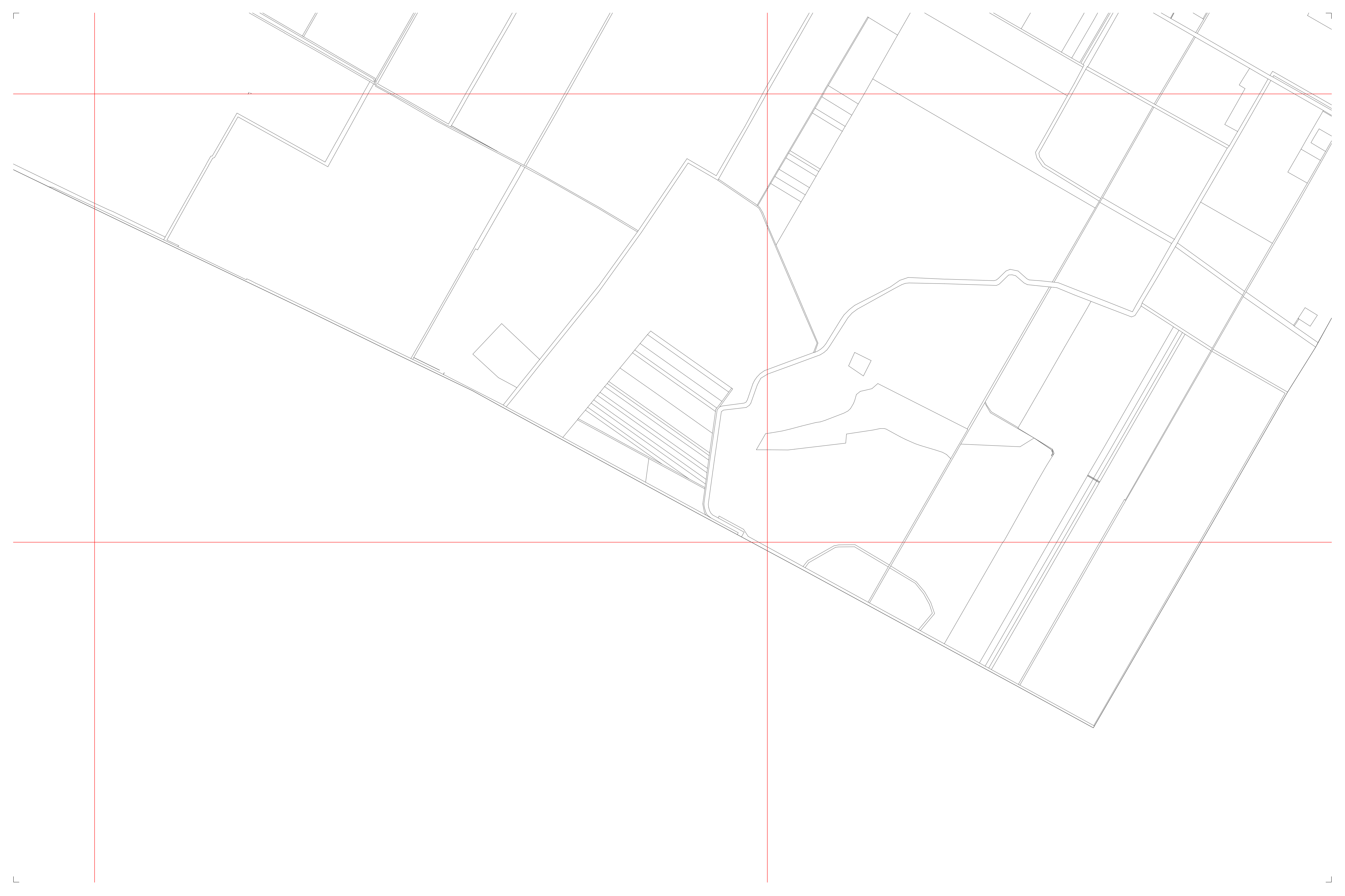

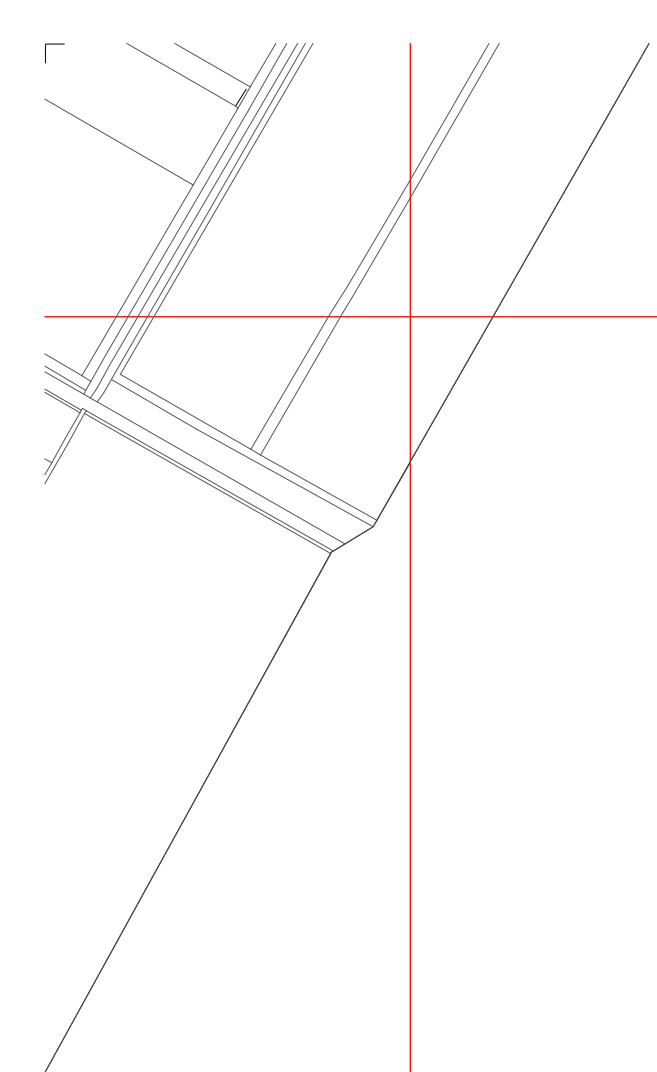

Jelmagyar



•zat:



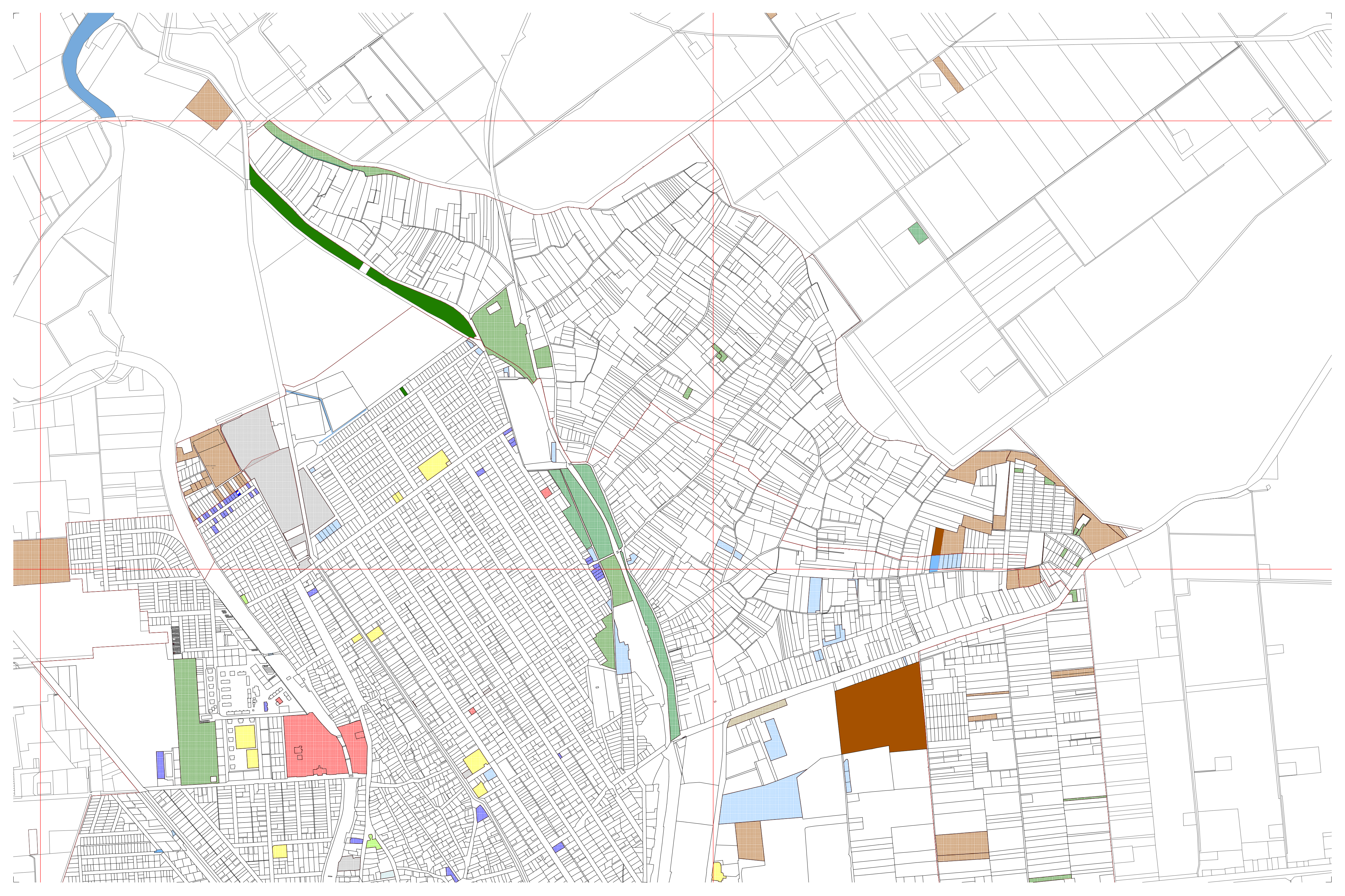

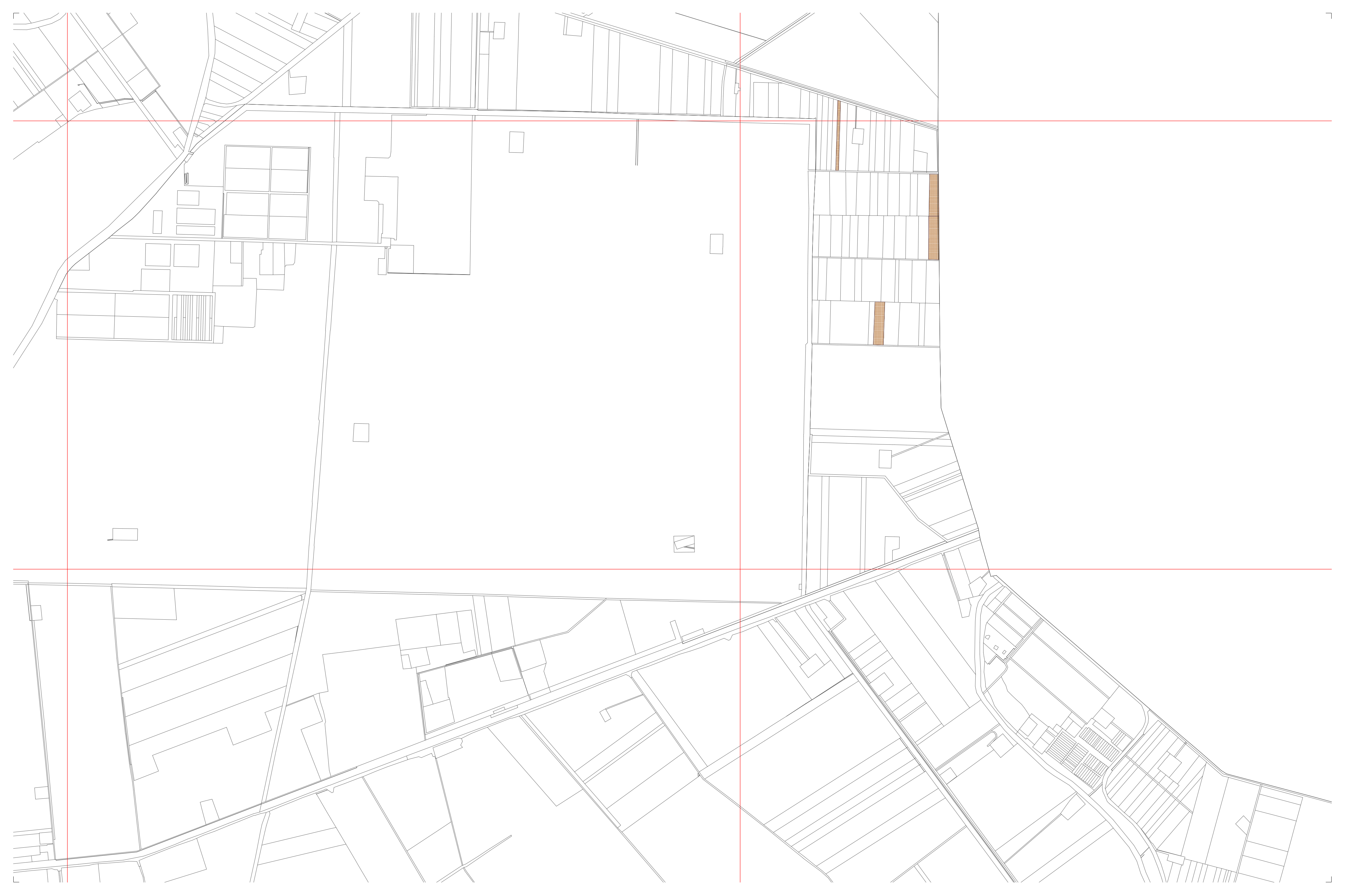



beép•tett

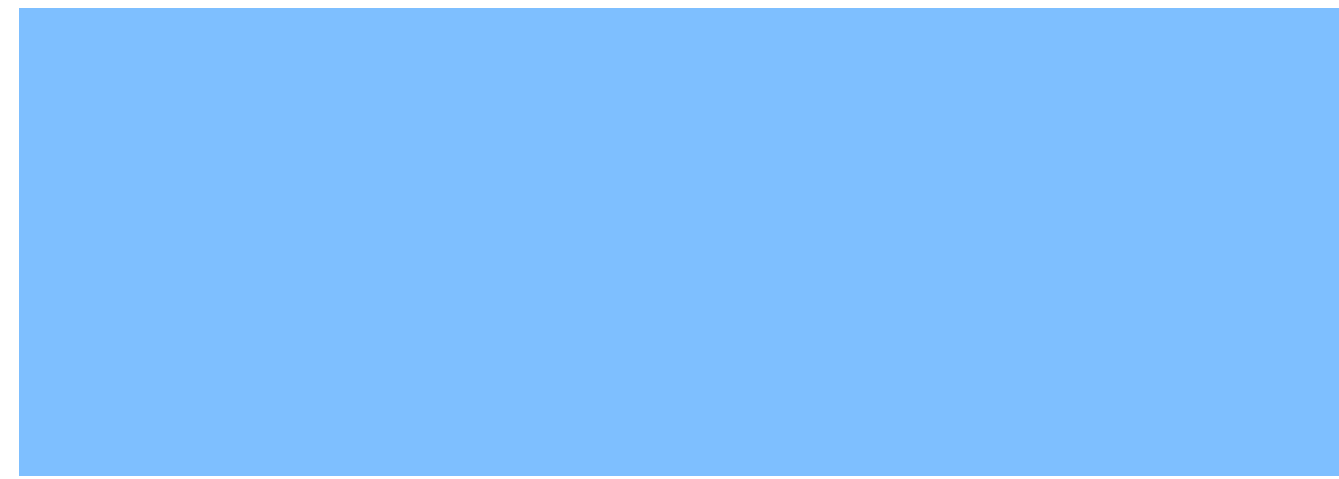

beép•tett



iskola, óvod



egészségü



szolg•ltat•s



len

oda

gyi

s



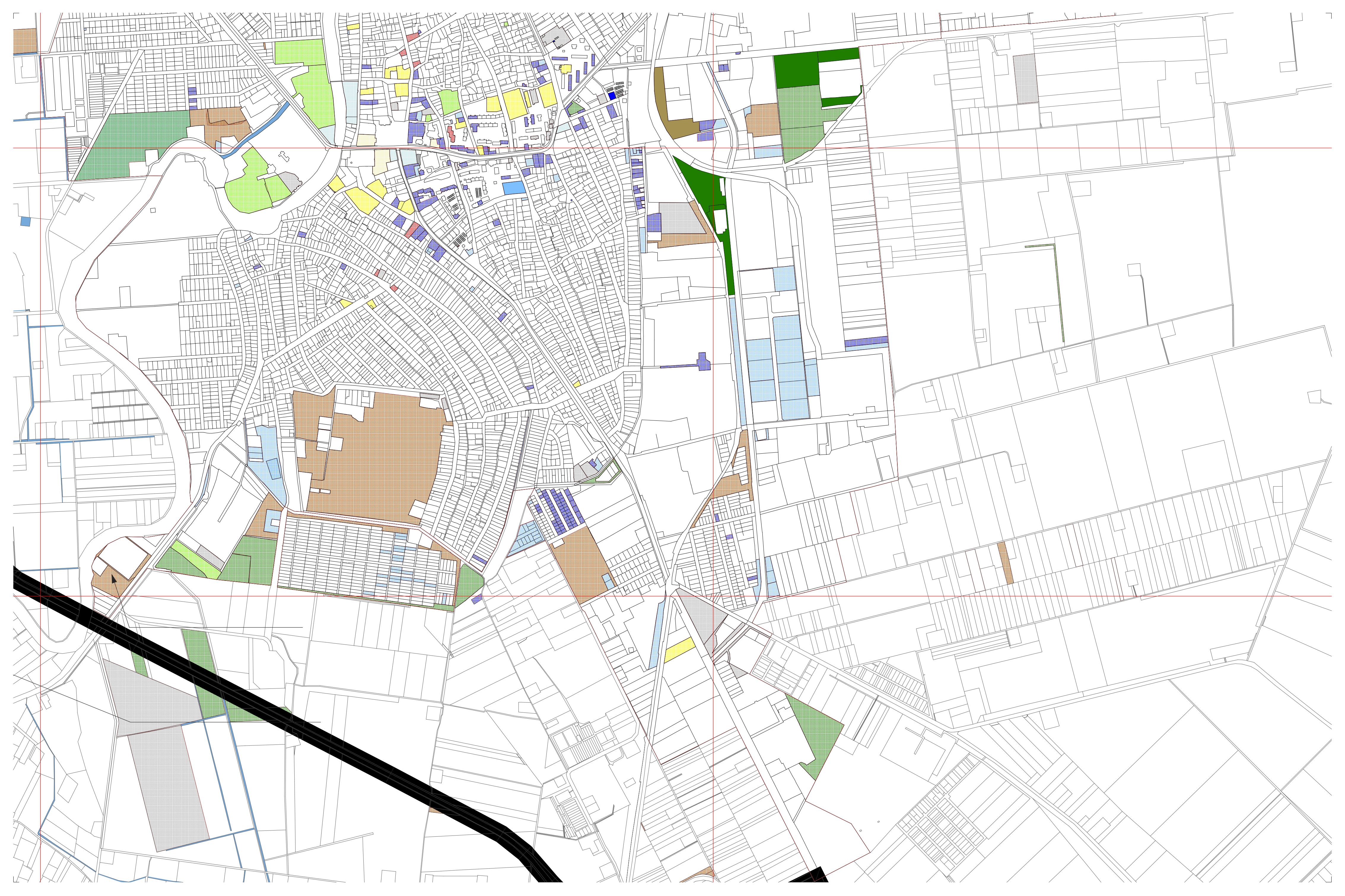



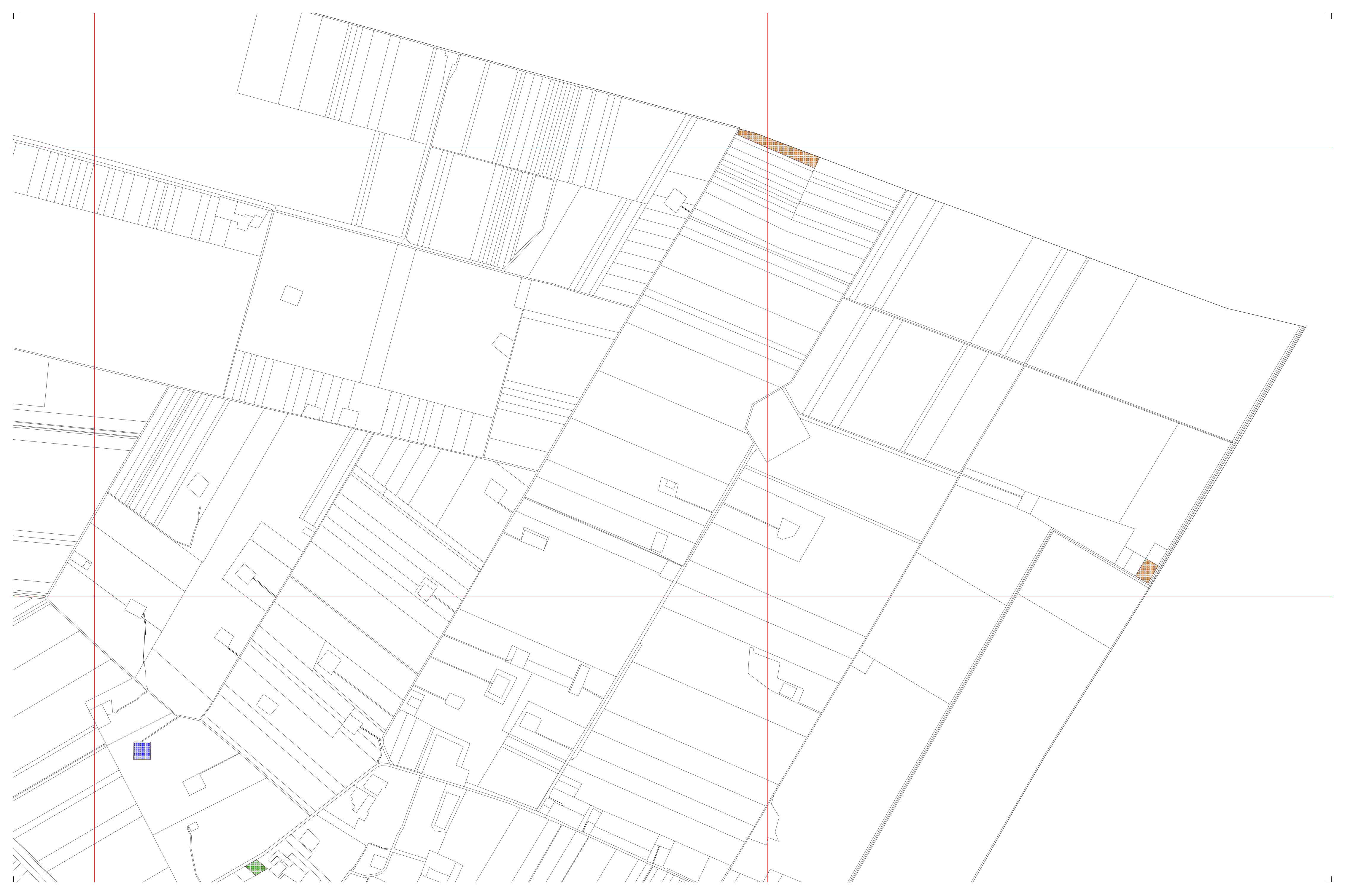



mezf_fgazd

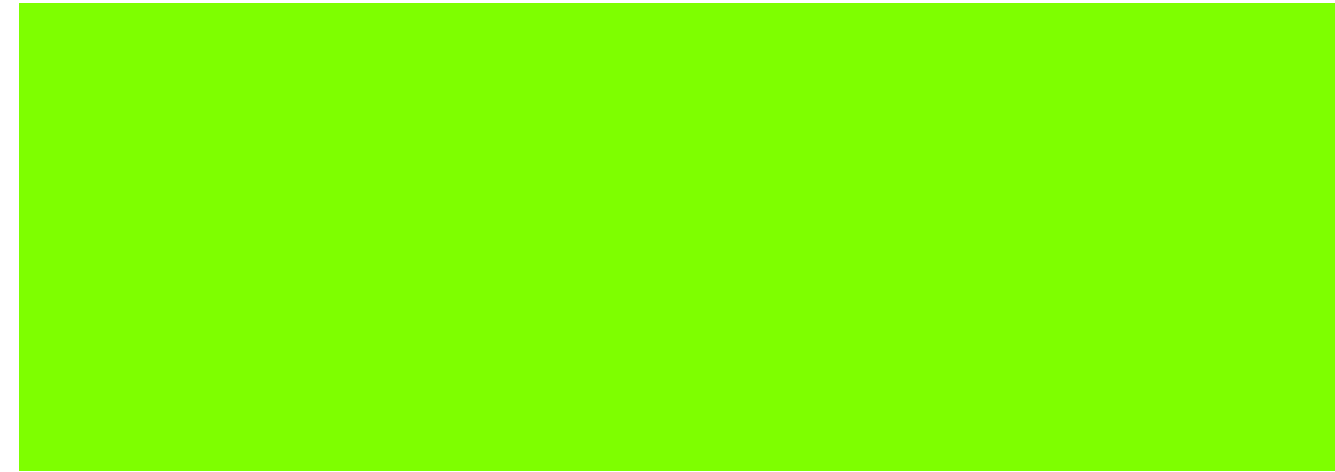

szabadid_f



zöldterüle

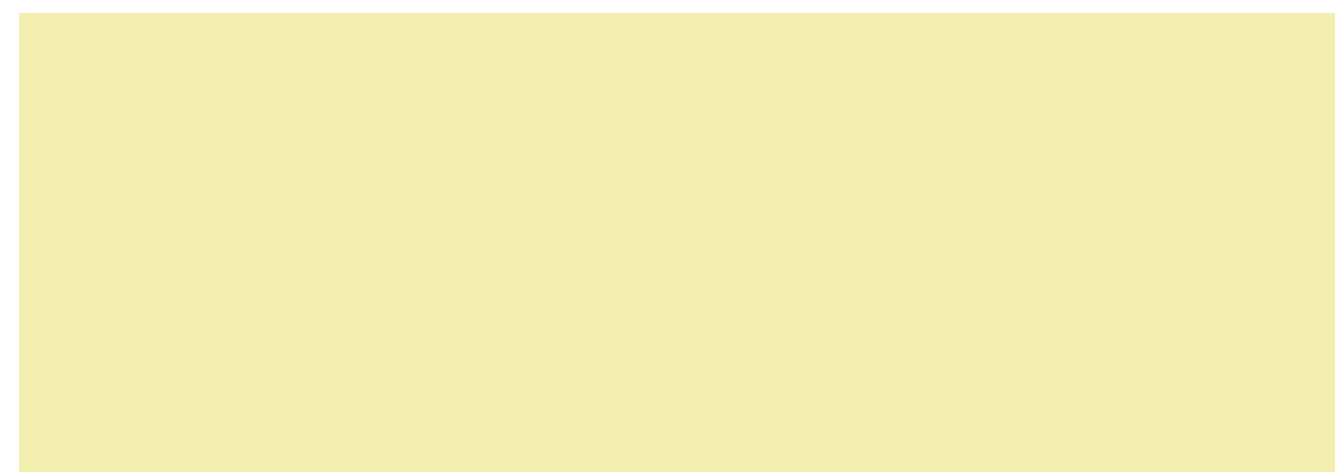

igazgat•s

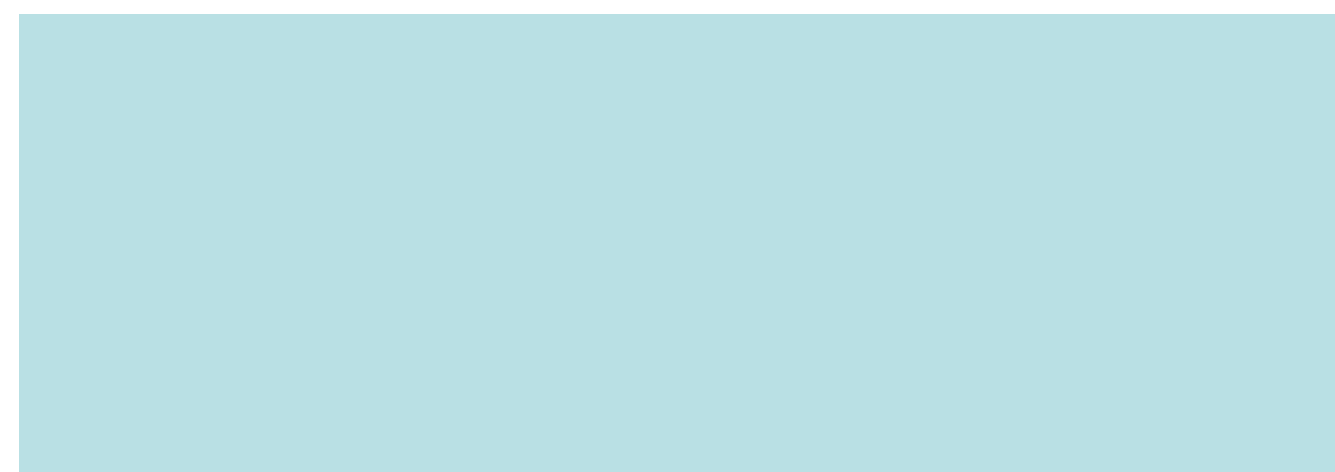

kultúr•lis



as•gi

st

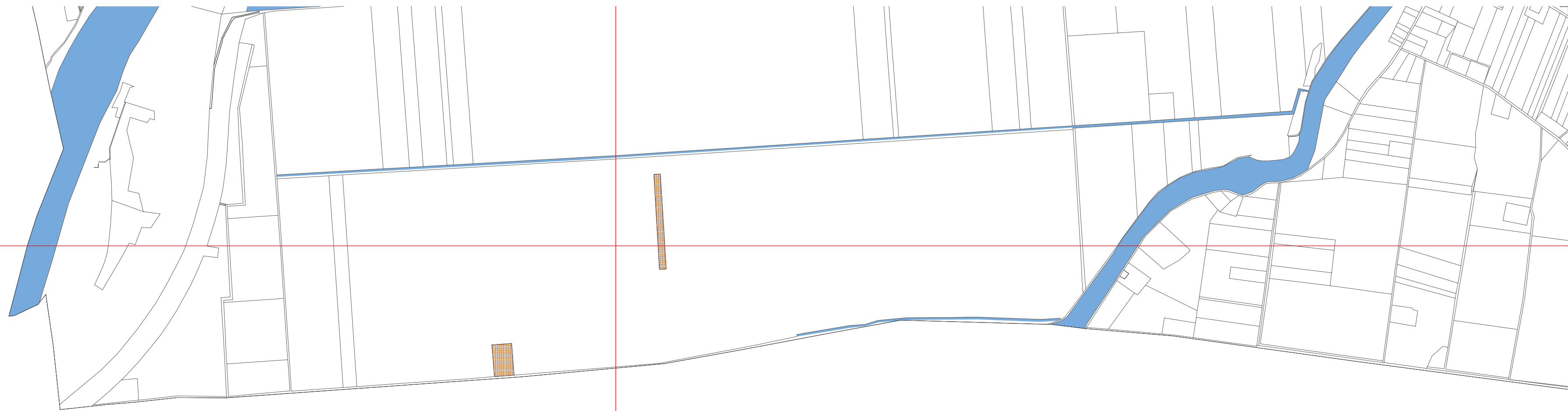

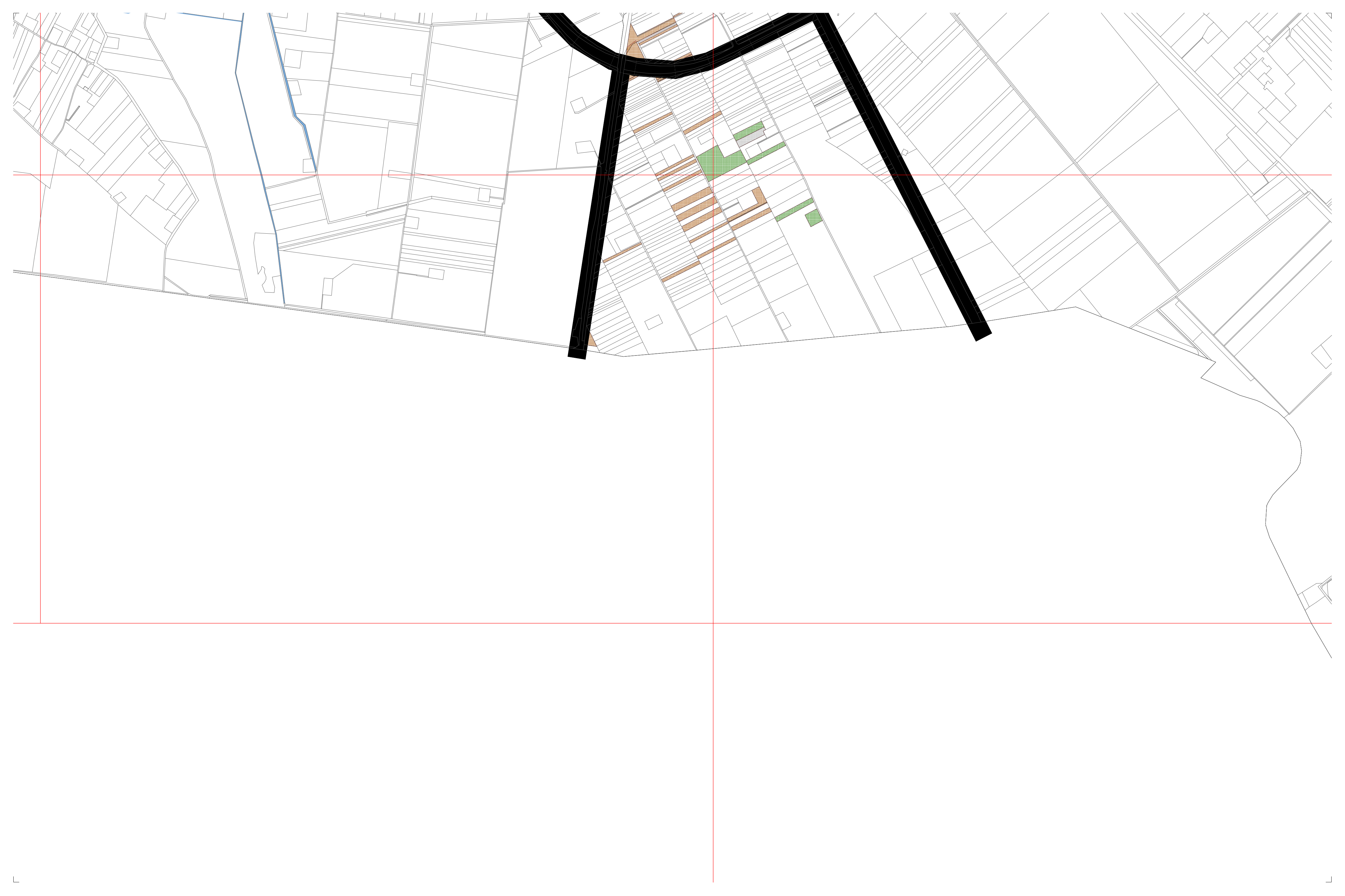



LAPIST

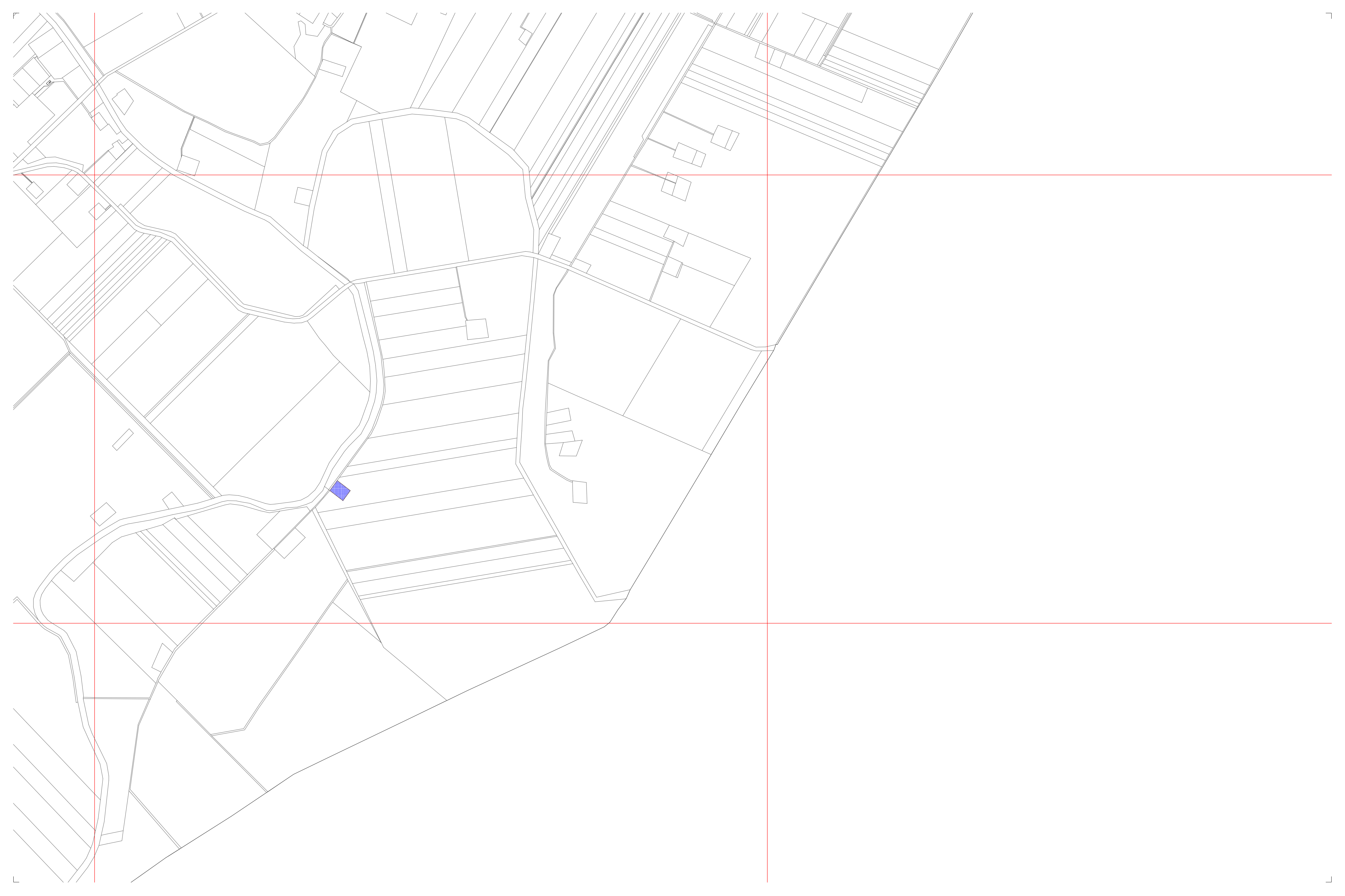

ipari

æt

